

iVA OPERATING MANUAL

Cable And Network Analyzer System



This document contains information which is confidential and the property of Kaelus, and which is not to be communicated to any person or company, or used in any way without the previous authorization of Kaelus.

Document Issue	Description of Document Change	Date	Drawn	Authorization
Rev A	Creation of document by Eng	2/3/24	L.W.	T.L

Precautions



WARNING: RF HAZARD

This series of instrument is capable of producing up to 10 milliwatts of radio frequency (RF) power in the 600 MHz to 2750 MHz frequency band. Users are reminded that proper precautions must be taken to minimize exposure to these RF fields to the recommended limits.



WARNING: CHARGING

Do not recharge batteries while inside an accessory or transport case. Do not charge in a moving vehicle. Do not operate or charge the equipment while inside an accessory or transport case.



WARNING: BATTERY

The iVA Series Cable and Network Analyzer is fitted with a non user replaceable lithium-ion battery(Li-ion). Rechargeable Li-ion batteries contain organic solvents and reactive materials. Erroneous handling of Li-ion batteries may result in heat generation, explosion or fire, possibly leading to injury.

Observe correct handling and disposal of Li-ion batteries.

DISCLAIMER: INTERFERENCE

The instrument uses similar frequencies to several cellular telephone systems. Kaelus and its agents or distributors accept no responsibility for interference to existing communications services as a result of improper operation or misuse. If the equipment is used in a manner not specified by the manufacturer, the protection provided by the equipment may be impaired.

GENERAL CONDITIONS OF USE

This equipment should be protected from the ingress of liquids and precipitation such as rain and snow. The equipment must be operated within the environmental conditions specified in Chapter 1.4. This equipment is not approved for use in hazardous atmospheres, locations or medical applications.

UNPACKING

Ensure that the total number of boxes of equipment is checked off against the delivery documentation. At the same time inspect for any obvious transit damage. Should any damage be noted, notify the carrier immediately to file a transit damage claim. Do not discard any packing material until notified by the carrier or Kaelus. Carefully unpack all containers and check that all items listed on the delivery documentation. Please notify Kaelus of any damaged or missing items from the shipment.

Table of Contents

1.	Operating Instructions	9
1.1	Introduction	9
1.2	Functional Description	9
1.3	Features	9
1.4	Specifications	9
1.5	Construction and Features	9
1.6	Installing Software	12
1.6.1	Installing software on your iPad	12
1.6.1.1	App Store Releases	12
1.6.1.2	Minimum System Requirements	12
1.6.2	Installing software on Android	13
1.6.2.1	Play Store Releases	13
1.6.2.2	Minimum System Requirements	13
1.6.3	Installing Software on Windows	14
1.6.3.1	Download from the Kaelus Website	14
1.6.3.2	Minimum system requiremets	14
1.7	Charging	15
1.7.1	Charging Constraints	15
1.7.2	Charging After the Battery has Been Run Flat	15
1.7.3	Charging Time	15
1.7.4	Battery Life	15
1.7.5	Safety	15
1.8	Switching on Your iVA	16
1.9	Bluetooth Connection Via Settings Menu	16
1.9.1	Bluetooth connection Windows	17
1.10	Connecting to your application	17
1.10.1	Selecting your iVA in windows .	18
1.10.2	Selecting Your iVA in the Application Device Menu	19
1.10.2.2	IVA Software Options	21
1.11	Side Menu	22

1.12	Traces Menu	23
1.12.1	Traces Menu Options	24
1.12.2	Trace Types	25
1.12.3	Trace Units	25
1.13	Plot Menu	26
1.13.1	Plot Menu Options	26
1.13.2	Subplots	27
1.14	Trace Zoom Functions.	28
1.14.1	Trace Autoscale	30
1.14.2	Trace Rest Scale	30
1.15	Return Loss Screen	30
1.16	Cable Loss Measurement	31
1.17	Transmission Measurement	31
1.18	Distance to Fault	32
1.19	Spectrum Monitor Measurement	33
1.19.1	Setting Sweep Start and Stop Frequency	33
1.19.2	Setting Markers	34
1.20	Stimulus Mode	36
1.20.1	Stimulus Mode Options	37
1.21	Setting Test Limits	37
1.21.1	Test Limit Options	38
1.21.2	Minimum Limit	39
1.21.3	Maximum Limit	40
1.21.4	Ripple Limit	41
1.21.5	Tolerance Limit	42
1.22	Generating Reports	43
1.22.1	Site Information Menu	43
1.22.2	Entering Contractor Details and Logo	44
1.22.3	Adding Photo's	45
1.22.4	Geotagging	46
1.22.5	Retrieving CSV data	46
1.22.6	Tags	46

1.22.7	Editing Reports	48
1.23	State Files	50
1.24	Settings	51
1.24.1	General Menu	51
1.25	Cleaning the Equipment	52
1.26	Turning off the IVA	52
2.	Troubleshooting Guide	53
3.	End of Life Statement	55
4.	Contacts	55

List of Figures

Figure 1	iVA Equipment View	10
Figure 2	Install Screen from the App Store.	12
Figure 3	Install Screen from the Play Store	13
Figure 4	Download from the Kaelus Website	14
Figure 5	Switching on the iVA	16
Figure 6	Select the iVA's to connect to by Serial number	16
Figure 7	Allowing the Unify app permissions via Bluetooth	17
Figure 8	Unify Application icon	17
Figure 9	IVA connected via USB in Windows	18
Figure 10	USB LED Indicator	18
Figure 11	Devices Menu	19
Figure 12	Side Menu	22
Figure 13	Add and remove traces menu DTF	23
Figure 14	Application, Plot Menu	26
Figure 15	Subplot Display	27
Figure 16	Application X axis Zoom	28
Figure 17	Application Y Axis Zoom	28
Figure 18	Application X and Y Zoom Together	29
Figure 19	Double tap and Slide Zoom	29
Figure 20	Return Loss Screen	30
Figure 21	Transmission Calibration Menu	32
Figure 22	Distance to Fault Display.	32
Figure 23	Spectrum Monitor, Override Stimulus	33
Figure 24	Marker Setting	34
Figure 25	Marker Focus	34
Figure 26	Trace Hold (Max-Min Menu)	36
Figure 27	Stimulus Mode	36
Figure 28	Limits Menu	37
Figure 29	Minimum Spec Limit	39
Figure 30	Max Limit Drawn on a Return Loss Trace	40

Figure 31	Ripple Limit on a Trace	41
Figure 32	Tolerance Spec Limit	42
Figure 33	Report Site Information	43
Figure 34	Merging External Reports Apple	43
Figure 35	Re-ordering Reports	44
Figure 36	Contractor Details Menu	44
Figure 37	Record and Photo Menu	45
Figure 38	Tag menu	46
Figure 39	Plot expanded view (Reports)	48
Figure 40	Edit Plot View	49
Figure 41	Remove a Plot	50
Figure 42	Settings General Menu	51
Figure 43	Settings Units	51

1. Operating Instructions

1.1 Introduction

This manual describes the operation of the iVA (Cable and Network Analyzer) developed by Kaelus.

The iVA Cable and Network Analyzer enables users to measure Through Loss/VSWR/Return Loss and the location of the VSWR/Return Loss faults in their RF infrastructure. The Bluetooth interface allows unprecedented measurement flexibility and opens up new & exciting possibilities in sweep testing.

The iVA is a rugged remotely controlled battery operated module that can be used with any Bluetooth enabled iOS iPad Android Tablet or Windows PC Laptop, Desktop or Tablet . The Unify Application used can also be use with other products available from Kaelus product range refer to the Unify Manual for more details.

1.2 Functional Description

The iVA can be connected to by an iPad via an application available in the APP Store, Android tablet via an application available in the Playstore or via a Windows application available from the Kaelus website . The iVA is connected via the Bluetooth interface or USB connection under windows .

1.3 Features

- Rugged and reliable; designed with tower climbers in mind
- Accurate measurement of swept VSWR/Return loss and Distance to Fault (DTF) in the RF Path.
- Simplifies site certification sweep testing dramatically reducing test time on site.

1.4 Specifications

Please refer to the [Datasheet](#) on our webpage

1.5 Construction and Features

The external details of the iVA test set are shown in Figure 1.



Figure 1 iVA Equipment View

1 Power On/Off Button

Power on turns on the iVA unit. A short touch will turn on the iVA, indicated by a Green LED (See item 3). A long touch until the Tx Rx activity LEDs flash then release will turn the iVA off.

2 Bluetooth Activity LED

Indicates when Bluetooth signaling is active

- Solid Blue indicates connected
- Flashing indicates disconnected

3 Power On/ Charge LED's

Solid orange indicates charging. Green indicates switched on.

4 Tx, Rx Activity LED's

Indicates when Transmit (Red led) or Receive (Green led) is active.

5 RF Input /Output Port

N Type connector or 4.3-10 Connector.

6 USB Port

USB Port covered by a protective splashproof cover. Charging the iVA battery is done through the USB port. Connection to your charger is done through the USB port.

7 Protective Cover

Protective cover for the RF Input Output connector.

8 Lifting Lug

Provides a fastening point for a lanyard or line to help prevent the unit being dropped, and support the measurement head near the cable end or measurement point.

9 Protective Cover Retaining Hook

Provides a fastening point to hook on the protective cover to keep it out of the way while connecting and making measurements.

1.6 Installing Software

1.6.1 Installing software on your iPad

1.6.1.1 App Store Releases

Typically the stand alone iOS installable file will be released via the App Store
Go to the App store and search for Kaelus Unify and press install.

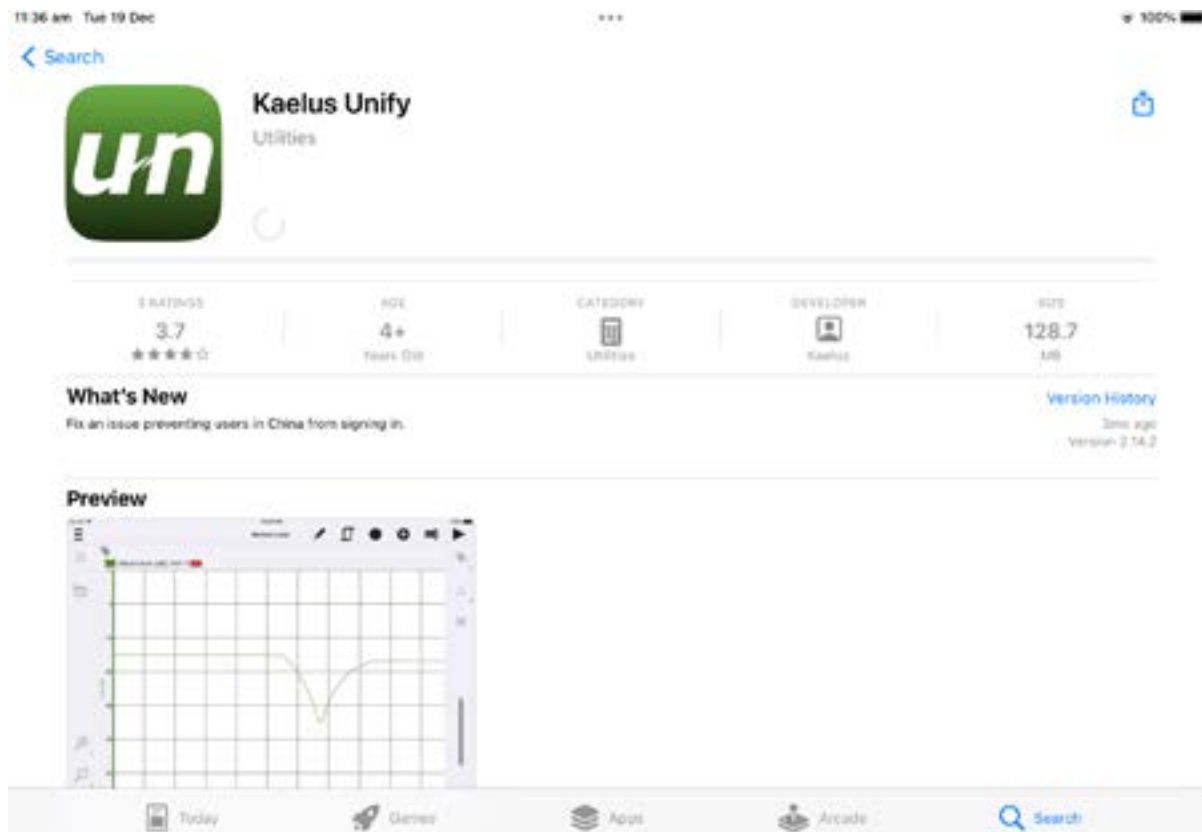

Figure 2 Install Screen from the App Store.

1.6.1.2 Minimum System Requirements

Minimum system requirements can be obtained from the kaelus website

1.6.2 Installing software on Android

1.6.2.1 Play Store Releases

Typically the stand alone Android installable will be released via the play store .
In the Google Play store search for Kaelus Unify and press install

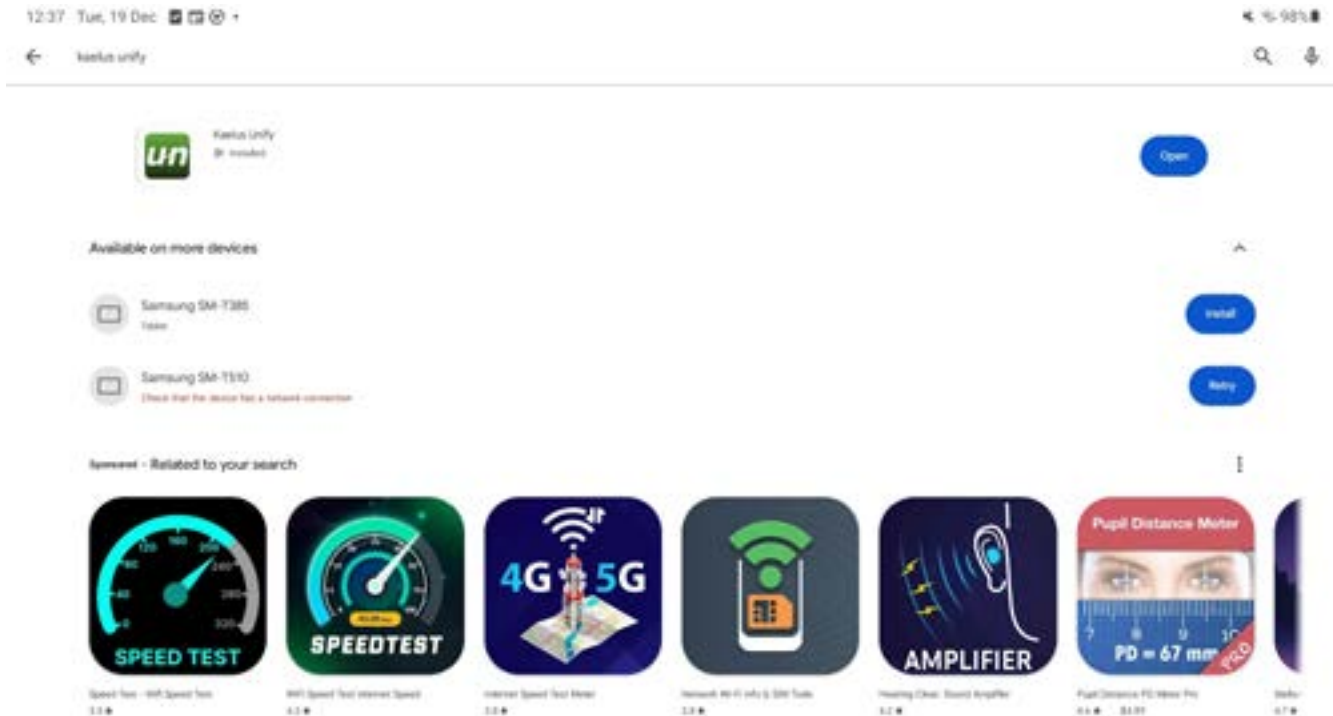

Figure 3 Install Screen from the Play Store

1.6.2.2 Minimum System Requirements

Minimum system requirements can be obtained from the kaelus website

1.6.3 Installing Software on Windows



Figure 4 Download from the Kaelus Website

1.6.3.1 Download from the Kaelus Website

Visit the Kaelus website and download from the Software releases section

1.6.3.2 Minimum system requirements

Minimum system requirements can be obtained from the kaelus website

1.7 Charging

The iVA has a non user replaceable 3.6V Li-ion battery, that is charged via the USB port.

1.7.1 Charging Constraints

There is a variety of charging currents delivered from USB Ports. Ideally your USB Port should be able to deliver 500mA of current or more. 500mA is sufficient for intermittent use at maximum operation current and charging, you may find that heavy continuous use will not allow you to take on extra charging with a minimal current USB port.

While long USB cables are handy for moving the iVA into harder to reach places. Low quality USB cables can reduce the power available to charge the iVA.

The iVA will self-limit at 1.2A, and is designed to charge from a number of different sources. A heavy use pattern may require the use of the supplied USB Charger.

The supplied USB charger and small USB cable is recommended for charging.

1.7.2 Charging After the Battery has Been Run Flat

The iVA has a number of protection systems to reduce the chance of battery damage from complete discharge. The iVA hardware will prevent higher current charging of a discharged battery. If discharged, it is necessary to charge the iVA while switched off initially for at least 1 Hour. Note : That if the iVA has an adequate charge level remaining, normal and higher charge rates can occur and normal use can commence immediately once connected for charging, lower current USB charge sources may not support continuous heavy usage.

If the iVA is not going to be used for a significant time and has been run flat, it is recommended to give the iVA at least an hours charge before storing. Li ion batteries can self-discharge at a rate of approximately 1% per month, if not used for many months a periodic recharge may be needed.

1.7.3 Charging Time

Charging time will depend on the USB port current capacity. A new iVA, switched off for charging with the supplied a 5V 1.2A charger can reach fully charged in approximately 3.5 Hrs.

1.7.4 Battery Life

Fully charged with continuous return loss sweeps and under Bluetooth control the iVA will last typically 3 Hrs of use. With connect and disconnect time, rigging and installation work time a nominal 8Hr work shift is readily achieved.

1.7.5 Safety

Any attempt to replace the internal battery could damage the unit. Care should be taken to not expose the battery to high temperatures and to not overcharge the battery.

1.8 Switching on Your iVA



Figure 5 Switching on the iVA

A momentary touch on the Power switch on the iVA. Note: the pre-use charging instructions in Section 1.7. Turn on the iVA prior to starting the iVA application. If you have recently installed or updated the iVA Application, ensure the iVA is charged and will be operating from a reliable power source. After initial installation or application update, it may be necessary for the application to update the iVA firmware and download the factory calibration data. It is necessary that the iVA and iPad remain on until these processes have completed.

1.9 Bluetooth Connection Via Settings Menu

In order for the iVA App to connect to the iVA, a Bluetooth connection must first be established via the settings menu. Make note of the serial number of your iVA and locate it in the tablets Bluetooth devices menu and connect. You will then need to allow the Bluetooth device to connect to the iVA Application. This will need to be repeated for all of the iVA's in use. iOS restricts the number of iVA's that can be connected to 4 (As of Version 9.0.2) and Android will allow up to 8..

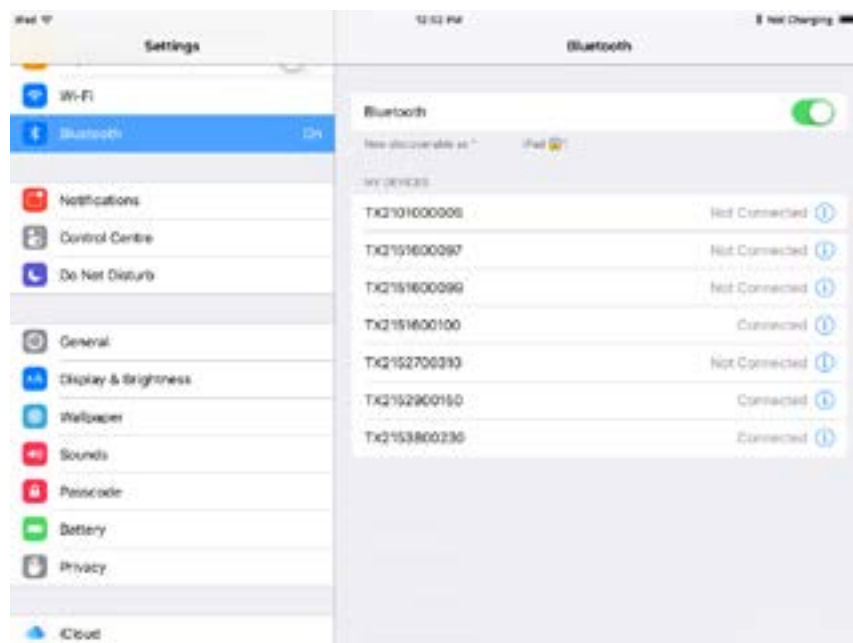

Figure 6 Select the iVA's to connect to by Serial number



Figure 7 Allowing the Unify app permissions via Bluetooth

1.9.1 Bluetooth connection Windows

IOS and Android applications both required bluetooth to be paired prior to connecting in the Unify app menu. Windows 10/11 do not require initial bluetooth pairing in the operating system, the available iVA devices will appear once the scan button is pressed.

1.10 Connecting to your application

Once you have installed the Application there will be an icon in your applications list. Click on it to start the program.



Figure 8 Unify Application icon

If the Kaelus Unify application icon is not visible on your screen, check in the Apps menu. Typically the Program will start on the devices menu screen to allow you to first connect to the iVA, when the iVA is first switched on the Blue LED will be flashing, indicating that the iVA is not yet paired to a iPad/Tablet/Windows.

1.10.1 Selecting your iVA in windows .

Unlike iOS and Android operating systems it is not necessary to first pair your iVA when using bluetooth before it will appear in the devices list . First ensure that your windows PC has bluetooth capability , if not, a USB bluetooth moule can be added to the PC or connection to the iVA can be made with a USB cable, USB mini . If the USB cable option is used that will take priority in devices list .



Figure 9 IVA connected via USB in Windows



Figure 10 USB LED Indicator

1.10.2 Selecting Your iVA in the Application Device Menu

Ensure the Bluetooth is fitted and enabled on your device, the Bluetooth switch can be found in the operating systems settings menu.

1.10.2.1 Devices Menu

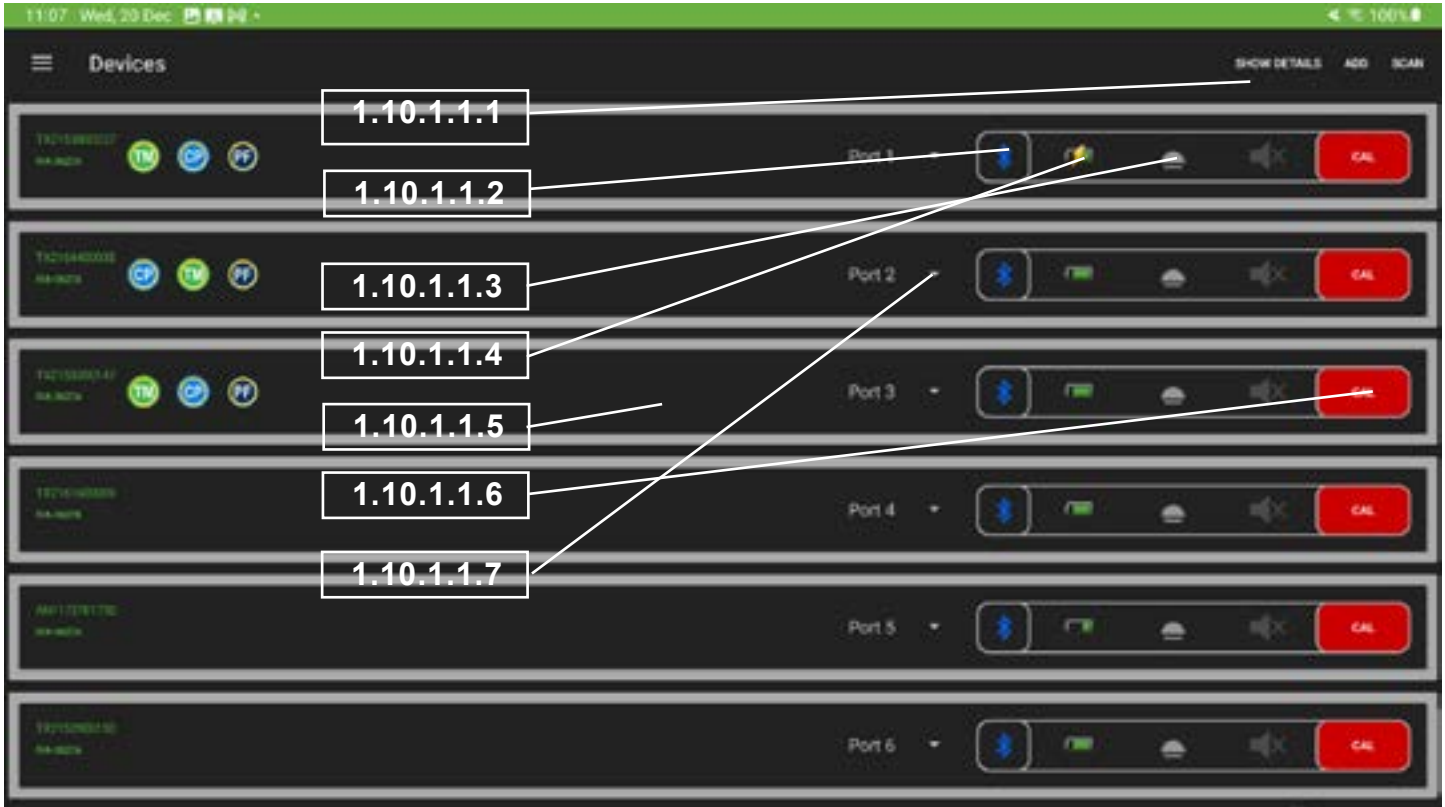

Figure 11 Devices Menu

1.10.2.1.1 Show Details

Displays iVA's device information and iVA firmware version.

1.10.2.1.2 Connect Icons

The icon will flash while establishing a connection to the selected iVA. Connection to your iVA can be confirmed in several ways. On the application the icon will stop flashing and be a solid . On the iVA the Bluetooth LED will change from flashing to continuous ON. The identify function, see Identify item below can also be used.

1.10.2.1.3 Identify

The identify function key allows you to get a visual response from the iVA/s you are connected to in your device list pressing  will cause the blue Bluetooth, red tx and green rx leds to flash for approximately 6 seconds. This allows you to view which is the physical device on your list.

1.10.2.1.4 Battery Charge Indicator

The Battery charge indicator, indicates the battery charge level and whether the iVA is charging via the USB port.



Charging



50% Charge remaining



Battery Low



Battery Very Low

1.10.2.1.5 Progress Bar

Shows the progress of the transfers to and from the iVA. This could be factory calibration data or firmware (ensures your iVA firmware is compatible with the application version you are using), and will occur on the first use of the iVA or after an update.

1.10.2.1.6 Enter Calibration Menu



Calibration saved



Requires calibration

When the user enters any test mode (Return Loss, Cable Loss, DTF), the calibration status will be displayed and color coded as described below. The accuracy of the iVA is quite good directly from the factory. However, it is highly recommended that an Open-Short-Load (OSL) calibration be performed to maximize data accuracy. The Calibration status will change depending on how much time has passed since the calibration was performed and if the temperature has changed by more than 8 degrees since the last calibration. The table below indicates the recommended uses for the different calibration states.

CAL Performed	CAL Status	Status Shown on Plots and Reports	Acceptable for Use as Follows
OSL Calibration	Last Calibrated Less than 12 Hours Prior	Last Calibrated Time Prior	Reportable Measurements
	Last Calibrated Between 12-36 Hours Prior	Last Calibrated = Uncalibrated	Fault finding and repairs
	Greater than 36 Hours	Last Calibrated = Uncalibrated	General quick check and repairs at a given measurement plane
	Last than $\pm 8^{\circ}$ C Temp Change	Last Calibrated Time Prior	Reportable Measurements
	Greater than $\pm 8^{\circ}$ C	Last Calibrated = Uncalibrated	Fault finding and repairs



From the table we can see that once the iVA has been given an OSL Calibration, the iVA calibration indicator will remain green for 12 Hours providing there has not been more than an 8 Degrees temperature change. The iVA can continue to be used for fault finding and repairs and then be re-calibrated for the site report.

1.10.2.1.7 Pull Down Menu

Selects what Port number is associated with the connected iVA

1.10.2.2 IVA Software Options

The following software options can be purchased for the iVA .

Indicator	Part	Description
	iVA-SW-TMA	Transmission Mode : Uses 2 or more iVA's one, as a stepped signal level signal source and the other as a receiver to provide a frequency reponse of a signal path.
	iVA-SW-FI-A	PIM Finder Mode : Used to find external PIM sources , used with an external bandpass pre-amp and Antennae either stand alone or in conjunction with controlling our Portable PIM analyser.
	iVA-SW-CPA	Channel Power Mode: Calculates channel power in a given bandwidth , either CW or modulated.

1.11 Side Menu



Figure 12 Side Menu

1.11.2.2.1 Side Panel Menu

Touch  to open and touch outside the panel to close, the state file name will show when the panel is opened .

1.11.2.2.2 Cable Loss. See Section 1.13

1.11.2.2.3 Transmission. (Optional Feature) See Section 1.17

1.11.2.2.4 Spectrum Monitor. See Section 1.19

1.11.2.2.5 PIM Finder (Optional Feature) See

1.11.2.2.6 Distance to Fault. See Section 1.15

1.11.2.2.7 Add New Test

This allows you to add a new test to the current state file

1.11.2.2.8 Stimulus . See Section 1.20

1.11.2.2.9 Devices. See Section 1.10.2

The devices menu allows you to scan and select the iVA device you want to use for your measurements.

Note: Your device/s must be connected first, in the Bluetooth settings before items 1.11.1.1.2 to 1.11.1.1.4 above and item 1.11.1.1.6 are able to operate. See 1.10.2.1 for more detail.

1.11.2.2.10 Calibrate Menu

1.11.2.2.11 Limits. Refer to Section 1.20

1.11.2.2.12 Report. See Section 1.22

1.11.2.2.13 Settings

1.11.2.2.14 Notifications

1.12 Traces Menu



Figure 13 Add and remove traces menu DTF

1.12.1 Traces Menu Options

1.12.1.1 Remove Trace

The highlighted trace will be removed.

1.12.1.2 Shows the Trace Number.

This shows the trace number for the current parameter menu, other traces could be Tr2, Tr1 and so on.

1.12.1.3 Add an Additional Trace

Adds a trace to the current display channel.

1.12.1.4 DTF Range

Sets the maximum measurement range and trace X Scale on the DTF graph.

1.12.1.5 Cable Type

There are a number of pre-configured cable types in a pull down menu. This populates items 1.12.1.6, and 1.12.1.7 automatically, if your desired cable is not displayed, select custom and enter items 1.12.1.6 and 1.12.1.7 from your cable datasheet.

1.12.1.6 Velocity Factor

The relative speed of the radio waves in the desired cable compared to air, being 1.00, Incorrect velocity factor entry can introduce errors in the distance to fault measurements.

1.12.1.7 Cable Loss Per Unit Length

Length Units can be set in the settings menu. Enter the cable loss per meter.

1.12.1.8 Annotations Switch

If the Annotations switch is on, the entered Limits are overlaid on the display, individual user entered spec limits can be applied to this trace by switching them on (See item 9).

1.12.1.9 Apply Limits Switches

Spec Limits entered in the Limits menu can be applied to the selected trace, via an ON/OFF switch in this sub-menu.





1.12.1.10 Open Limits Menu

This will take you directly to the limits edit menu See Section 1.20

1.12.1.11 Override Stimulus Menu

Switch this on to set specific frequency stimulus for this trace.

1.12.1.12 Trace memory

Refer to Figure 25, The Trace memory function will store the currently focused trace into memory by pressing , the memory icon is a toggle function, a solid  symbol indicates the memory has contents already. Memory traces are indicated by a dotted trace line See Figure 25. If a solid  symbol is indicated, pressing it will erase the current memory, pressing  will move the current focused trace into that memory.

1.12.1.13 Trace Group

Traces in the same group are executed in order of trace number. If you have multiple iVA's connected and want traces to execute at a similar time, the traces can be allocated to a separate group or groups.

1.12.1.14 Trace Math (Optional Feature)

The Trace math menu can from the currently highlighted trace. Add or subtract another displayed trace, or add or subtract a previous memory trace of the highlighted trace See Section 1.12.1.12.

Note : The traces will need to be the same type

1.12.2 Trace Types

Different trace types can be included on the same measurement channel allowing for quick comparisons on the same display.

Trace types available include .

1.12.2.1 Return Loss

See Section 1.15

1.12.2.2 Cable Loss

See Section 1.16

1.12.2.3 DTF

See Section 1.18

1.12.2.4 Spectrum

See Section 1.19

1.12.2.5 Transmission

See Section Section 1.17

1.12.3 Trace Units

The trace units available will depend on the trace type selected above.

1.12.3.1 dBm

Decibels with respect to a 1 mW in 50 Ohms

1.12.3.2 mW

milliwatts in 50 Ohms

1.12.3.3 dB

dB return loss or Cable loss

1.12.3.4 VSWR

Voltage Standing Wave ratio

1.12.3.5 Mag

Magnitude

1.12.3.6 Real

The real component of the complex characteristic.

1.12.3.7 Imag

The imaginary component of the complex characteristic.

1.12.3.8 Degrees

The degrees of Phase shift.





1.13 Plot Menu

Channel frequency stimulus is used by default on traces, See Figure 13 to Override



Figure 14 Application, Plot Menu

1.13.1 Plot Menu Options

1. Plot menu
2. Run
Selects between trace running  and stopped 
3. Trace Modules
 - 3.1 Single sweep 
The highlighted trace will be swept once
 - 3.2 Continuous Sweep
The highlighted trace will be swept continuously
 - 3.3 All Single
All traces will be swept once.
 - 3.4 All Continuous
All traces will be swept/repeated Continuously. 
4. Add and remove traces. See Section 1.12
5. Plot start frequency
6. Plot stop frequency

7. Record menu, take photo, choose photo, record selected trace.
8. Record Icon
9. Rename test.
10. Subplots. See Section 1.13.2

1.13.2 Subplots

Subplots determine how traces are displayed in a given channel. Having 1 subplot will cause the whole trace screen to be used and all traces in that channel to be displayed on top of each other. Having the same number of subplots as traces, will cause the trace display to be divided horizontally for each trace. If you have more traces than subplots, the traces will be distributed evenly between subplots, these are added in trace order. As an example, if you have 4 traces and 2 subplots, trace 1 will be on subplot 1, trace 2 will be on subplot 2, trace 3 will be back to subplot 1 and added there, trace 4 added to subplot 2.

If you have more subplots configured than you have traces, then the number of subplots displayed will be the same as the number of traces. If you want some traces to appear on the same subplot, use the preceding info to plan how you allocate each trace number. There is a maximum of 4 traces on each channel display.

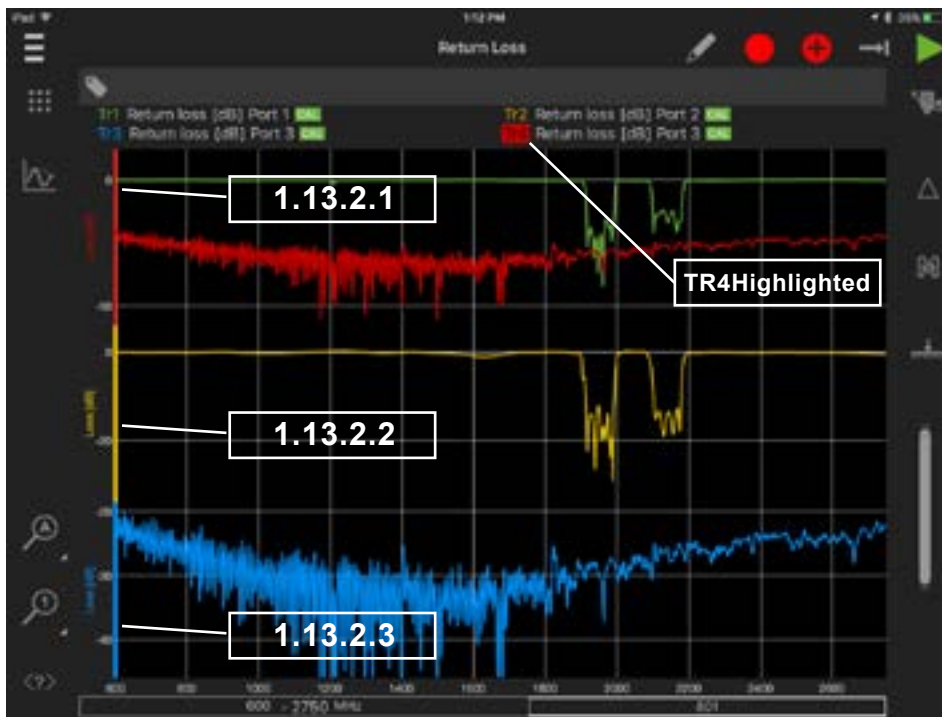

Figure 15 Subplot Display

1.13.2.1 First Subplot

Note : The subplot has 2 traces, the Y Axis is red as Tr4 is highlighted. If Tr1 was highlighted the Y axis would be green.

1.13.2.2 Second Subplot

1.13.2.3 Third Subplot

Note : When subplots and traces are added to reports, they are all added as individual Traces to the report.

1.14 Trace Zoom Functions.



Figure 16 Application X axis Zoom

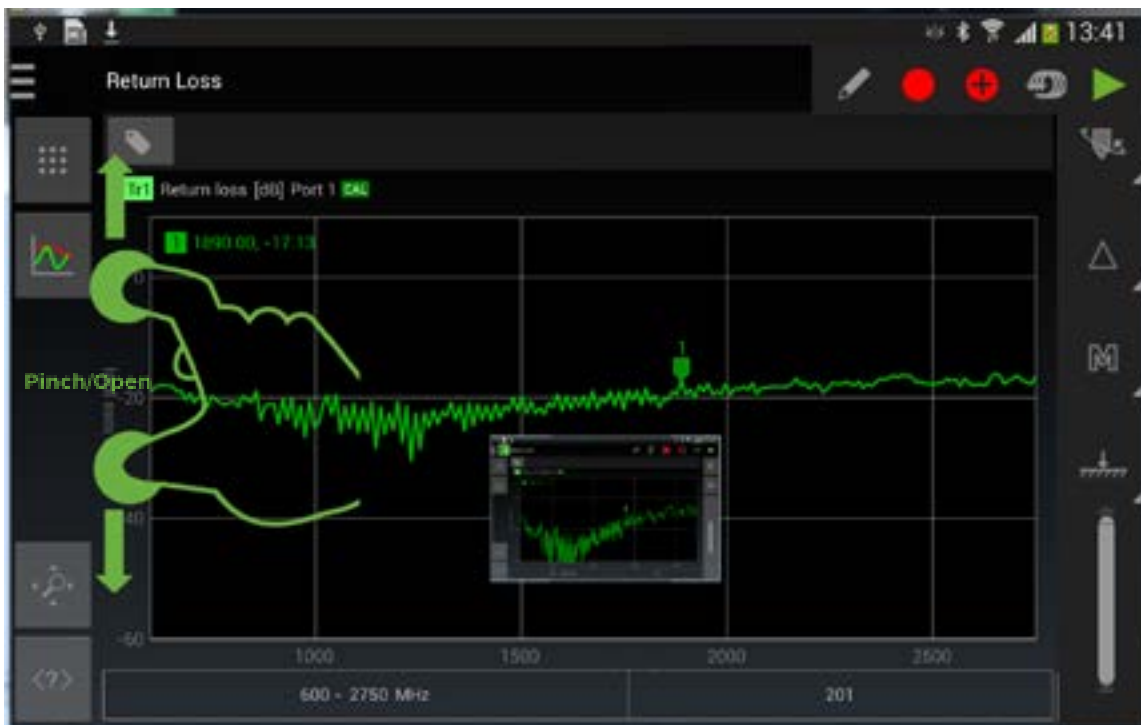

Figure 17 Application Y Axis Zoom



Figure 18 Application X and Y Zoom Together

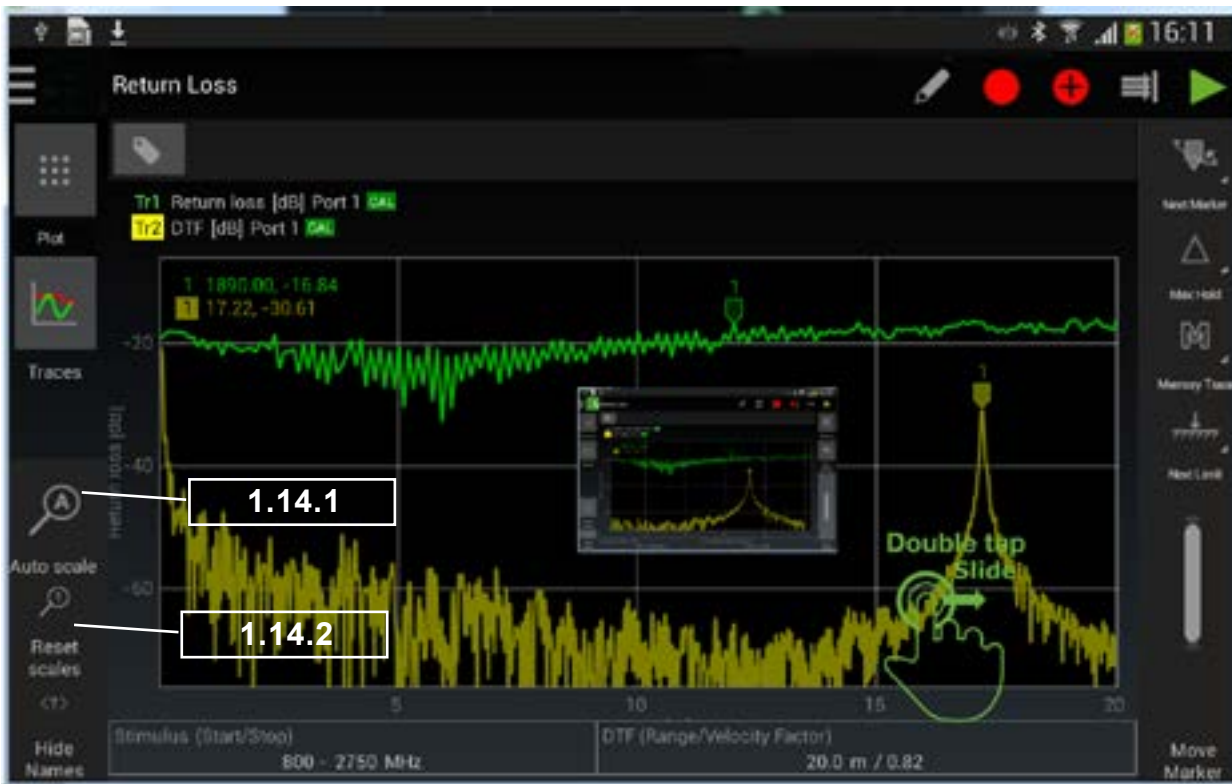

Figure 19 Double tap and Slide Zoom

1.14.1 Trace Autoscale

1.14.1.1 Autoscale (Short Press)

The currently selected trace will autoscale to fit the current screen or subplot area.

1.14.1.2 Autoscale (Long Press)

All traces on the display will autoscale to fit in their respective screen or subplot areas.

1.14.2 Trace Rest Scale

1.14.2.1 Reset Scale (Short Press)

The currently selected trace will reset to the default trace scaling .



1.14.2.2 Reset Scale (Long Press)

All traces on the display will reset their scale to the default trace scaling.

1.15 Return Loss Screen



Figure 20 Return Loss Screen

1. Plot Menu. Set parameters for this measurement plot. See section 1.13
2. Add and delete measurement tags menu. See Section 1.22.6
3. Traces menu. Add and edit traces to the display. See Section 1.12
4. Reset scales. Reset zoom settings. See Sections 1.14.1,1.14.2
5. Show/Hide Button Labels.
6. Display for Start/Stop Stimulus Frequency.
7. Display for the number of plot/measurement points. Edited via the Trace menu. See Section 1.12
8. Edit Mode name.
9. Add measurement markers (Long press), Change highlighted marker on the selected trace (Short press).
10. Trace Memory on/off. See Section 1.12.1.12
11. Move highlighted marker.
12. Calibration indicator.
13. Enter the State Files menu. See Section 1.23
14. Switch between single or continuous sweep.
15. Start/Stop trace/measurement.
16. Record (Record display for a report)
17. Record Progress Icon  appears as the trace sweeps.
18. Spec limit display.
19. Trace Pass/Fail indicator 
20. Picture Menu. See Section 1.22.3

1.16 Cable Loss Measurement

Cable loss is measured by measuring return loss to a shorted end of the Cable under test, then halving that loss to find the cable loss. First do an OSL (Open Short Load) calibration on the iVA , See Section 1.10.2.1 . Then fit the iVA to one end of the cable under test and the OSL short to the other end of the cable under test.

1.17 Transmission Measurement

 Signifies this feature is locked. See your Kaelus dealer to add this feature.

Transmission mode allows you to characterize insertion loss between two or more points. For transmission mode between 2 or 4 iVA's need to be connected. See Section 1.9, allow each Bluetooth device to communicate with the Kaelus iVA Application. Make note of the ports each iVA is connected to. Setup the transmission traces required between the ports in the traces menu. Once the traces have been created. Calibration items will appear in the calibration menu to Calibrate between the ports you have selected in your transmission traces. Calibrate using an N type through connector. The iVA's that need to be connected together will flash their Tx and Rx LED's when the Calibration item is selected.

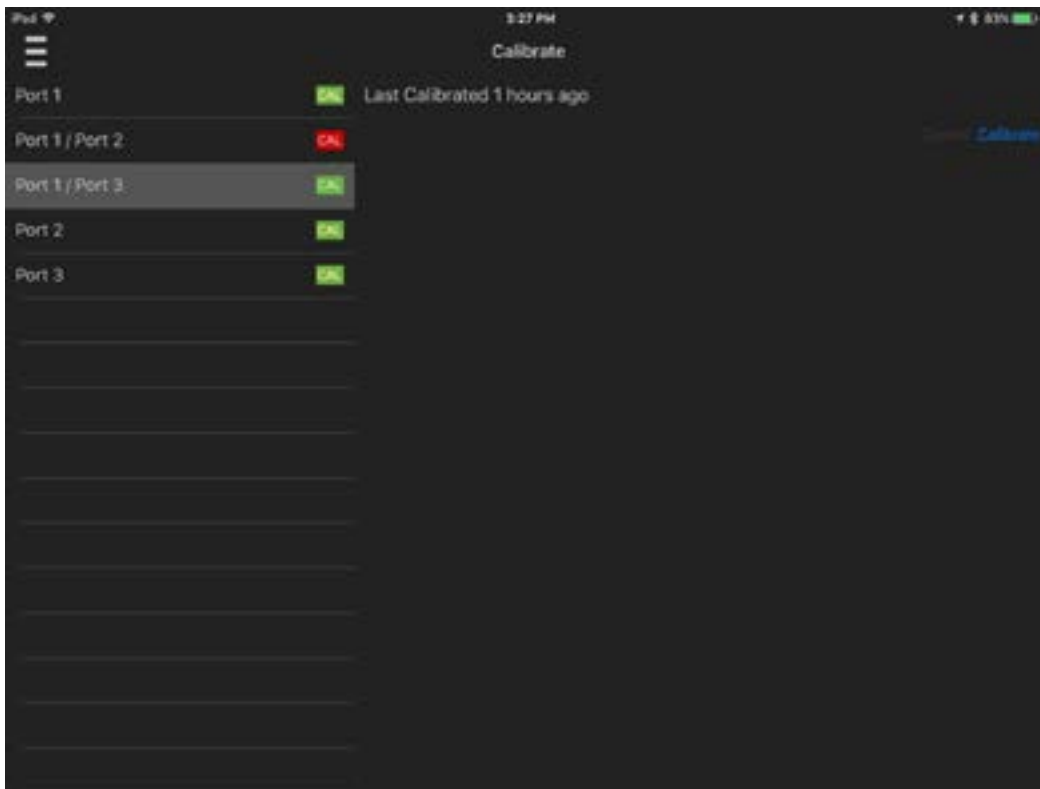

Figure 21 Transmission Calibration Menu

1.18 Distance to Fault

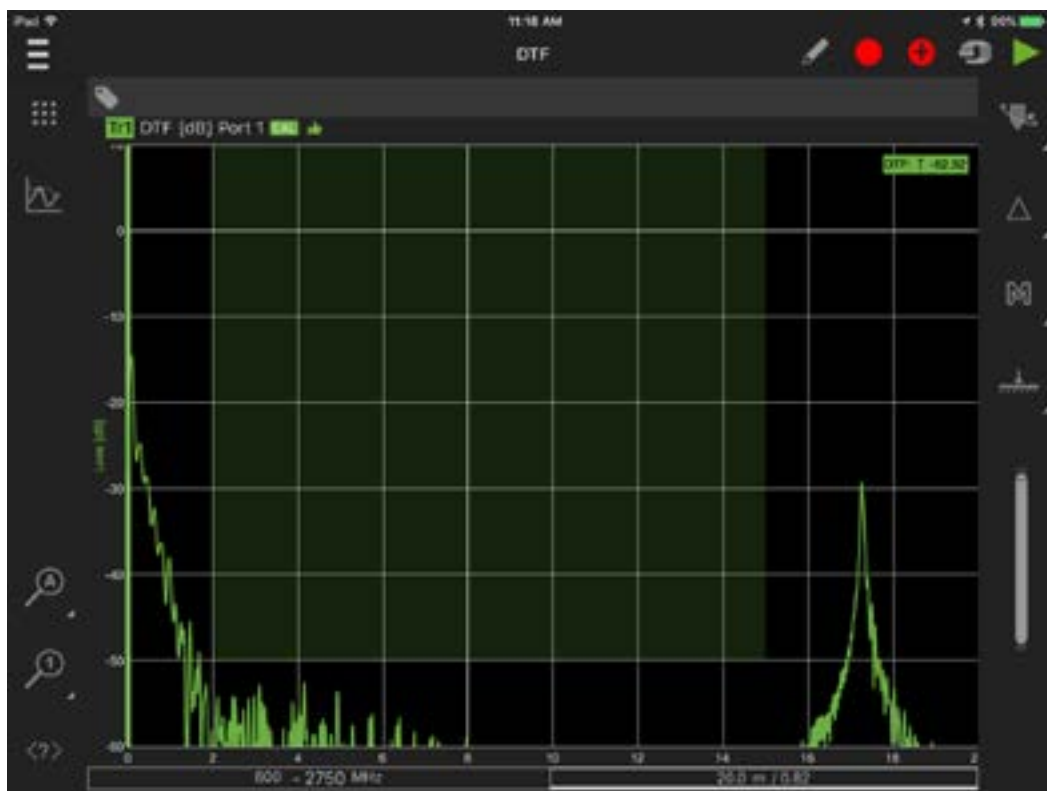

Figure 22 Distance to Fault Display.

1.19 Spectrum Monitor Measurement

1.19.1 Setting Sweep Start and Stop Frequency



Figure 23 Spectrum Monitor, Override Stimulus

1.19.1.1 Spectrum Monitor Sensitivity Range

A Pull down menu has 2 sensitivity ranges, -50dBm to +20dBm and -115dBm to -35dBm

1.19.1.2 Override Stimulus Switch

Allows you to select a different start and stop frequency for this trace. If disabled the default start and stop frequency from the channel menu (Section 1.13) is used.

1.19.1.3 Start Frequency

This sweep start frequency will be applied only to the selected trace.

1.19.1.4 Stop Frequency

This sweep stop frequency will be applied only to the selected trace.

1.19.1.5 Points

This enters the number of measurement points for the selected trace.

Note: The resolution bandwidth of the spectrum monitor function is 17KHz .

1.19.2 Setting Markers



Figure 24 Marker Setting

1.19.2.1 Marker Focus (Short Press) Marker Menu (Long Press)

A short press on next marker switches between each of the markers in turn on the currently selected trace. A Long Press activates the markers menu.

1.19.2.2 Add Marker

Add a marker to the currently selected trace. Refer to Figure 24

1.19.2.3 Remove Marker

Remove currently selected marker from the trace. Refer to Figure 24



Figure 25 Marker Focus

1.19.2.4 Marker Type

Marker type pop up menu appears, these include Value, Max and Min marker types. Refer to Figure 24

1.19.2.4.1 Value Marker

Value markers allow you to enter an absolute X value, once an absolute marker value has been entered, this can be further adjusted by the slider control or entering a new value.

1.19.2.4.2 Max Marker

When both max and min Marker types have been selected it is possible to enter a threshold value. The Max marker will ignore maxima below the threshold value.

1.19.2.4.3 Min Marker

When both max and min Marker types have been selected it is possible to enter a threshold value. The Min marker will ignore minima above the threshold value.

1.19.2.4.4 LocalMax

Local max markers are initially located at the first peak after the trigger point, or at the X axis point if provided. Localmax markers can be locally adjusted by the move control. See Figure 24.

1.19.2.4.5 LocalMin

Local max markers are initially located at the first null after the trigger point, or at the X axis point if provided. Localmin markers can be locally adjusted by the move control. See Figure 24.

1.19.2.4.6 Absolute

Absolute markers are able to be set to an arbitrary point on the trace graticule, Both (X Value and Y Value) can be entered.

1.19.2.5 Marker reference menu

This marker pop-up menu allows the user to select what point the marker result is referenced to. In its simplest form Origin, is the origin of the trace (0,0), this gives you absolute marker values. In addition to this on the pop-up menu, any other currently set marker on any other trace can be compared as a result shown on your current marker result. TrX signifies the trace number. Tr1-X Indicates the marker number on that trace. So to do a Delta measurement from Tr1-1 (Trace 1 Marker 1) Marker 2, the delta result would have it's reference set to Tr1-1 , Marker 2 will then show the difference in frequency and level from marker 1 on trace 1 .





1.19.2.6 Marker Focus/Marker menu

A Short press toggles focus between markers on the current trace, if a marker has focus it can be edited directly in the marker menu, the Marker Scroll Bar functions will also be attached to it, if it has focus.

1.19.2.7 Marker Scroll Bar

If the marker that has focus is an adjustable type (Localmax, Localmin, Value) you can slide up and down on the move scroll bar to move/adjust the marker position.

1.19.2.8 Trace Hold

A Short Press toggles between max hold off  and max hold on  . Likewise if Min Hold is set will toggle between min hold off  and min hold on  See 1.19.2.9

1.19.2.9 Trace Hold Menu

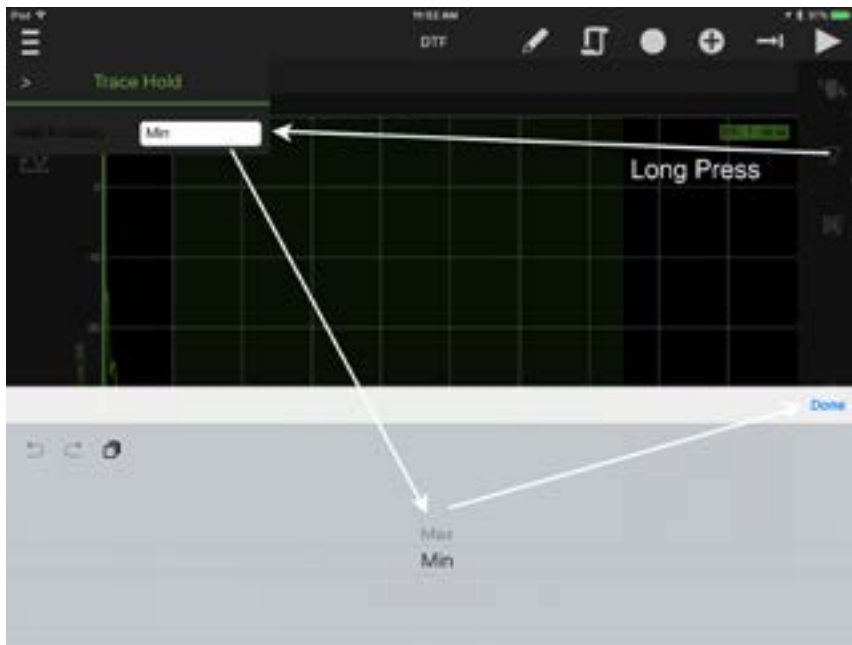

Figure 26 Trace Hold (Max-Min Menu)

1.19.2.9.1 Trace Hold Max

Holds the maximum trace value accumulated over time.

1.19.2.9.2 Trace Hold Min

Holds the minimum trace value accumulated over time.

1.20 Stimulus Mode

This mode allows the iVA to be used as a signal source. The output power is Typically 0dBm. A sequence of frequencies and time on periods can be programmed and is repeated continuously while Tx is active. If only one frequency step is programmed a continuous signal is produced when 1.20.1.3 run is pressed. All steps are repeated in a loop while run is pressed.



Figure 27 Stimulus Mode

1.20.1 Stimulus Mode Options

1.20.1.1 Add Stimulus step

To add a new stimulus step to the sequence. User enters the frequency and the time duration the RF will be on before stepping to the next frequency.

1.20.1.2 Remove Stimulus step

Highlight the stimulus step to be removed by touching anywhere on the step; the icon will change from greyed to bold, press “Remove”.

1.20.1.3 Stimulus Run/Stop

Press Run and the Tx sequence will commence and repeat. Press to stop transmit.

Note: Stimulus mode completely occupies the selected iVA/Port and it’s controller. No other function can be performed when the iVA is active (transmitting) in the Stimulus mode.

1.21 Setting Test Limits

Test limits can be entered and enabled per trace. There are several test limit types that can be applied to a given trace. Single or multiple limits can be applied to the same trace giving great versatility.

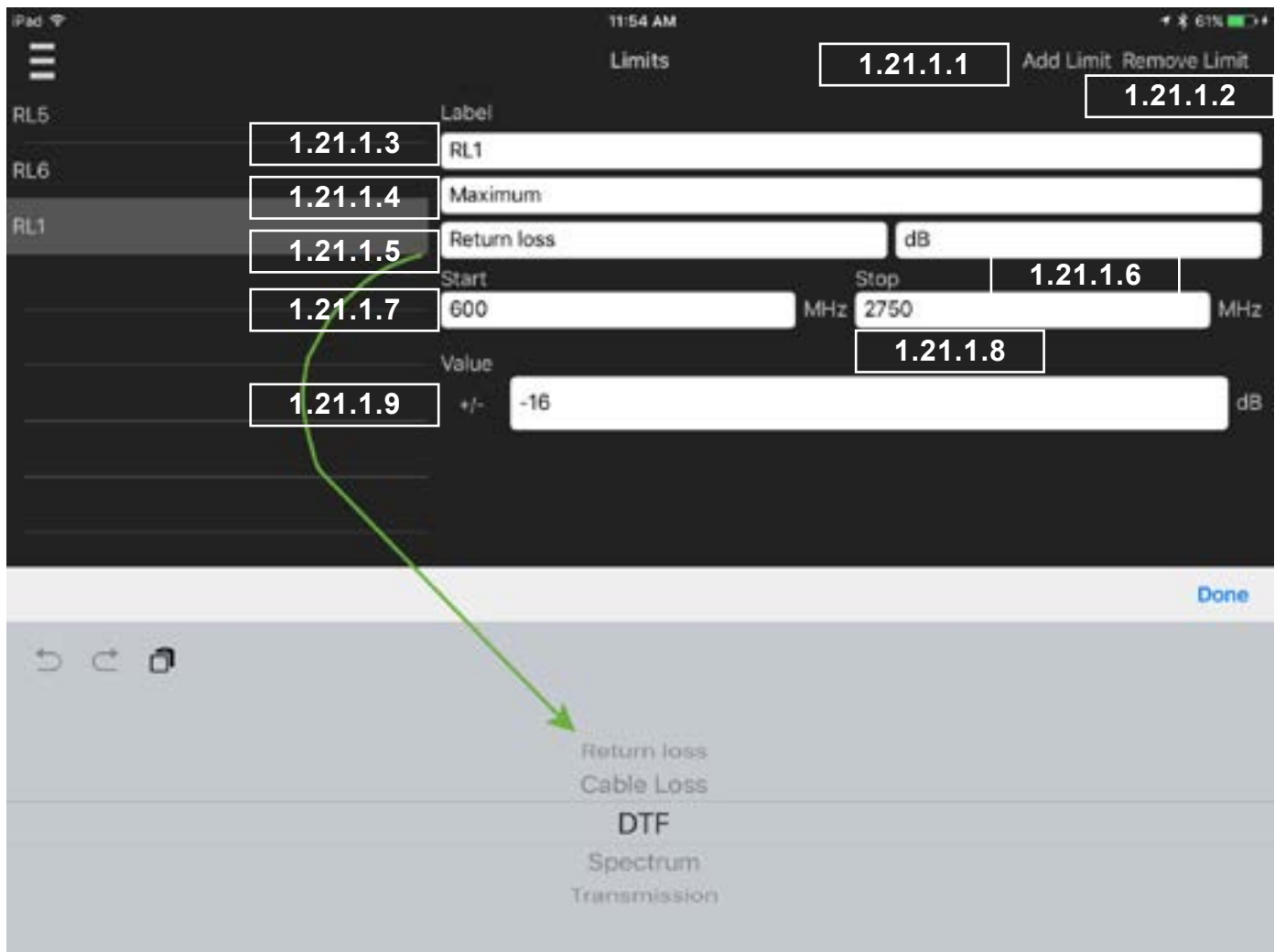

Figure 28 Limits Menu

1.21.1 Test Limit Options

1.21.1.1 Add a new Limit

Press “Add Limit”, a default label of New Limit will be given to the new limit and it will be appended to the end of the list. Highlight the New Limit and edit your new specification limit as outlined in the following sections.

1.21.1.2 Remove Limit

Highlight the Limit to be removed, and press “Remove Limit.”

1.21.1.3 Limit Label Field

Edit the Label for your specification. This label will appear in the corner of the trace when the limit is enabled. It will also appear on your test report and test report preview screen. It is also used to label your limit enable switches.

1.21.1.4 Limit Type Field

Provides a pull down menu allowing the limit type to be selected.

1.21.1.4.1 Minimum Spec Type

Refer to Figure 29

1.21.1.4.2 Maximum Spec Type

Refer to Figure 30 and Section 1.21.3

1.21.1.4.3 Tolerance Spec Type

Refer to Figure 32 and Section 1.21.5

1.21.1.4.4 Ripple Spec Type

Refer Figure 31 and Section 1.21.4

1.21.1.5 Spec Limit Trace Type Field

The type of trace the Limit can be applied to needs to be specified, these include DTF, Return Loss, Cable Loss, Spectrum and Transmission (optional test capability).

1.21.1.6 Measurement Units

This provides a pull down menu that allows measurement units to be selected.

1.21.1.7 Start Point

This specifies the start point the spec limit is applied over, this can be start frequency or the starting distance if used with DTF (Distance to Fault) measurements.

1.21.1.8 End Point

This specifies the end point the spec limit is applied over, this can be end frequency or the end distance if used with DTF (Distance to Fault) measurements.

1.21.1.9 Value

The limit value can be entered here this can be the ripple value, maximum level, minimum level. For tolerance specs , this will be the range above and below the center Value.

1.21.1.10 Center

Used with tolerance spec limits, specifies the center of the tolerance window, the value sets the amount above and below the center value. Only appears for Tolerance spec limits.

Note: A limit cannot pass unless there is sweep data that covers it's full range (Start Point – End Point), sweeps must be equal to or outside the Limits set. When testing against limits please ensure your sweep is configured appropriately.

1.21.2 Minimum Limit

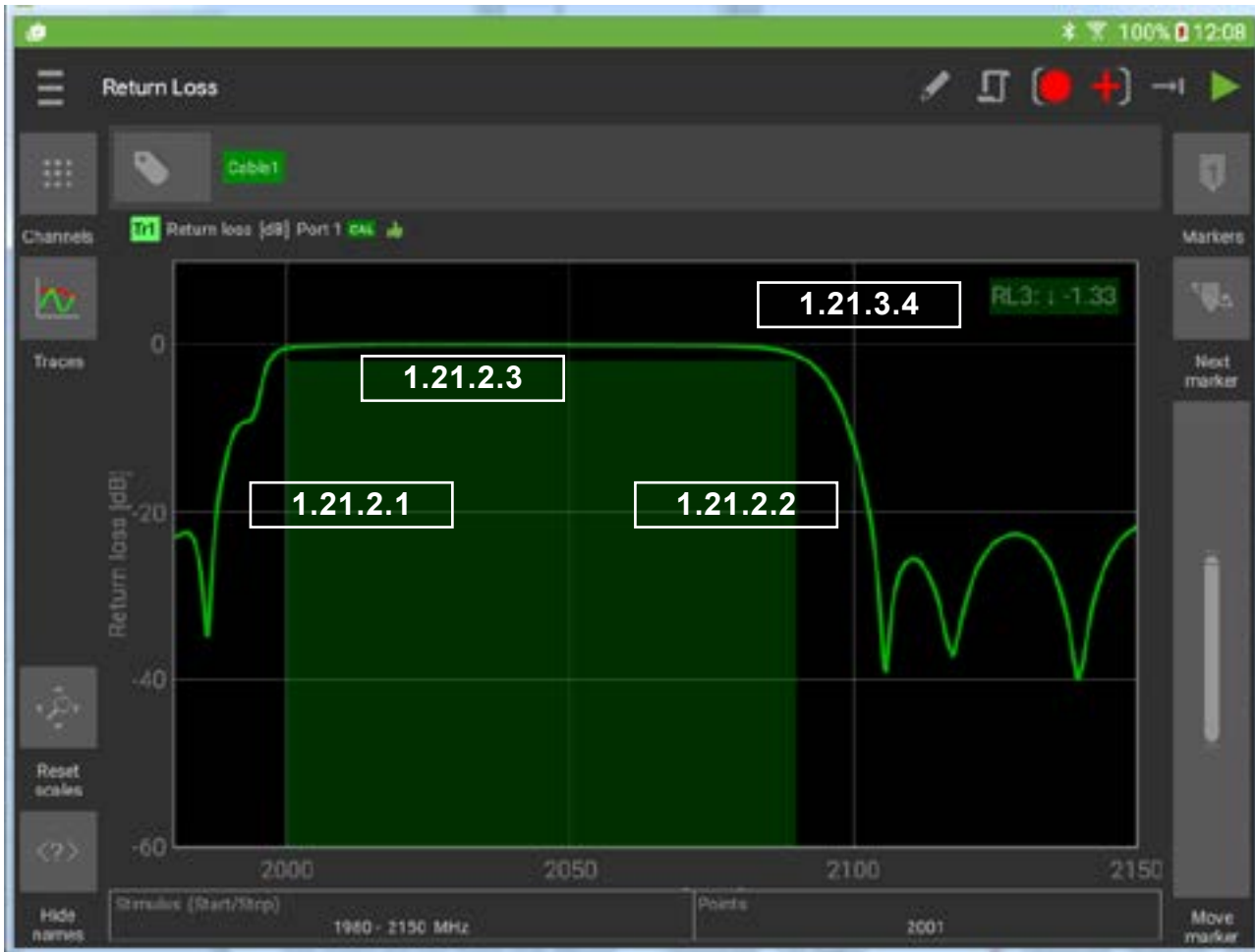

Figure 29 Minimum Spec Limit

1.21.2.1 Minimum Limit Start

This is the starting point that spec level is applied over in this case 2000MHz.

1.21.2.2 Minimum Limit Stop

This is the end point that spec level is applied over in this case 2090MHz.

1.21.2.3 Minimum Limit Level

1.21.2.4 Limit label, type and result

The limit label shows the label you created in the limits menu, the down arrow shows this is a Minimum spec limit. There is a result shown here also, between the start and stop points the trace has a Minima of -1.33

1.22.1.8 Reorder

This function allows you to change the order of items in the report. The first tap selects the item to be moved. The second tap selects the item that the moving item will be placed in front of.

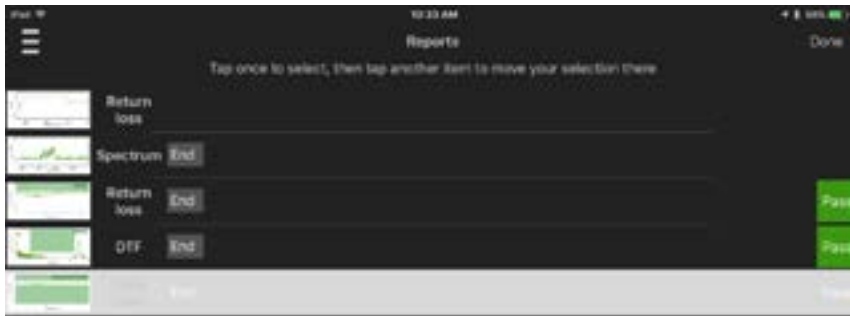

Figure 35 Re-ordering Reports

1.22.2 Entering Contractor Details and Logo

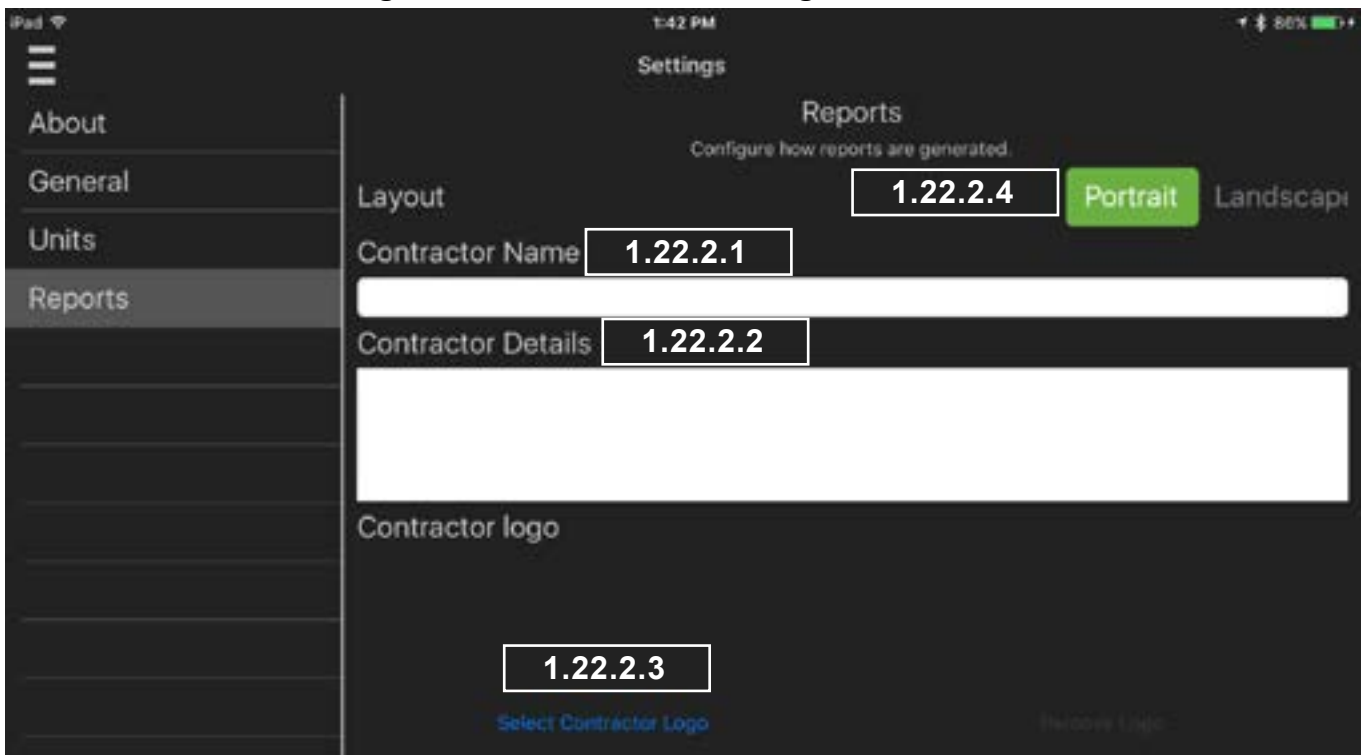

Figure 36 Contractor Details Menu

1.22.2.1 Contractor Name

Contractor name can be entered here it will appear at the start of every report. Contractor name details and logo are retained when the tablet is switched off or other state files are loaded. This menu is accessed via the Navigation/Settings Menu. See Figure 12

1.22.2.2 Contractor Details

These details will appear after the Contractor Name at the top of the report.

1.22.2.3 Select Contractor Logo

A small PNG or JPG file constituting your business logo can be added from the device's image gallery.

1.22.2.4 Portrait/Landscape Selection

Reports can be generated in Portrait or Landscape orientation.

1.22.3 Adding Photo's

Photos can be added to a report from any of the trace plot screens. See Figure 37 and Section 1.22.3.1



Figure 37 Record and Photo Menu

1.22.3.1 Select Photo and Record Menu

Touch here to make the Photo and record sub-menu appear.

1.22.3.2 Take Photo

This will select your default device Photo program and open it. Take your desired photo. Depending on your photo/camera application, you will be asked to use it or press ok. The Photo will then be taken and added to the report. If your device has a geotag fix, the location of the photo will also be added to the report. In windows a file can be chosen.

1.22.3.3 Choose Photo

A photo that already exists in your Gallery can be chosen and included in your reports. When this key is pressed a list of your Apple device's photo options will appear. Select the location, check the photo to include (one at time). They will then be added to the report and geotag data if available.

1.22.3.4 Record Selected Trace

Touch this will cause the currently selected trace, it's tags and pass/fail result, if limits are used, to be added to the report.

1.22.4 Geotagging

As part of the installation process you will have been asked for the iVA application to share your location data. This is the first step, the second step is that location data needs to be available. A simple way to check this is to see if an application like google maps will show your current location on a map. Various technologies through the operating platform can be used to derive your location for geotagging. See the troubleshooting Section 2 on Geotagging to isolate some of the causes why the operating system may not be supplying Geotag data to the Unify Application.

1.22.5 Retrieving CSV data

In some cases it might be desirable to have your plot/trace data in a CSV (Comma Separated Values) format. This can be used to import the data to a spreadsheet or database program. The report *.zip file can be opened with a conventional zip file reading program, CSV files have already been included for you in the report zip file.

1.22.6 Tags



Figure 38 Tag menu

1.22.6.1 Enter and Exit the Tag Menu

The tags menu icon appears on all measurement mode screens, touch on it to make the tags menu appear; you need to touch this icon again to exit the tags menu.

1.22.6.2 Current Tags List Area

Prior to entering the tags menu, whatever trace, Mode, Port, Channel that was being highlighted/used will have its particular set of tags now displayed in the current tags list area. Tags are displayed in color order as per the tag scope selection order. Tags can be dragged up and down to be associated with a different scope if required. Alternatively you can select a tag and use the scope buttons.

1.22.6.3 Tag Scope Selection

The tag you enter in the Tag Entry Area (See 1.22.6.4) will be associated with a tag scope. How many places the tag is visible in will depend what scope is selected when you press create tag.

1.22.6.3.1 Global

Global tags are added everywhere, every plotted result in the report will have the tag you have entered placed against it.

1.22.6.3.2 Test

Everything in the currently selected test will have the tag you enter associated with it. Tests can one of the default tests such as Spectrum monitor shown in Figure 38, or one of the other selectable test. If you create a second Spectrum monitor test, your tag would only associate with the test currently selected when you entered the tags menu.

1.22.6.3.3 Trace

Only the currently selected Trace will have the tag you enter associated with it.

1.22.6.3.4 Port

In the devices menu each connected iVA is associated with a Port, 1, 2, 3 etc. Any trace using the selected Port will have the tag you enter associated with it. This tag grouping can associate with an iVA's physical location. Cable1 as example.

1.22.6.4 Tag Entry Area

Tags should be entered here with no spaces, ensure the desired group is selected first, the press create tag or hit Enter.

1.22.6.5 Highlighted tag for deletion.

Highlight/select one of the tags in the current tags list area as shown. Pressing  will delete it.

1.22.6.6 Tags Pool

Enter your required Grouping then touch one of the tags in the tag pool to re-use any of the tags you have already entered. An  appears by each tag in the pool to allow it to be deleted.

1.22.6.7 Remove All

Remove all the tags in the tags pool.

1.22.7 Editing Reports

Existing reports can be edited, it is possible to change the trace view, markers, tags, site, operator details in reports. If a report is in memory (in report view) it can be edited directly, existing reports can be merged with the current report in memory and the merged report edited. If you only want to edit an existing report, save any unsaved data you want to keep and open the existing report file. If you are importing a file from a file sharing service the same steps shown in Figure 34 should be followed, if there is no report in memory the external file alone will be imported. Pressing new See Section 1.22.1.2 can be used to clear the report in memory if needed. Site, Operator, Location and Comments can be edited directly as in Section 1.22.1 . Individual Plots can be edited by touching on the individual plot to expand its view, at this level individual plot comments and tags can be edited or added in the same way as new reports.

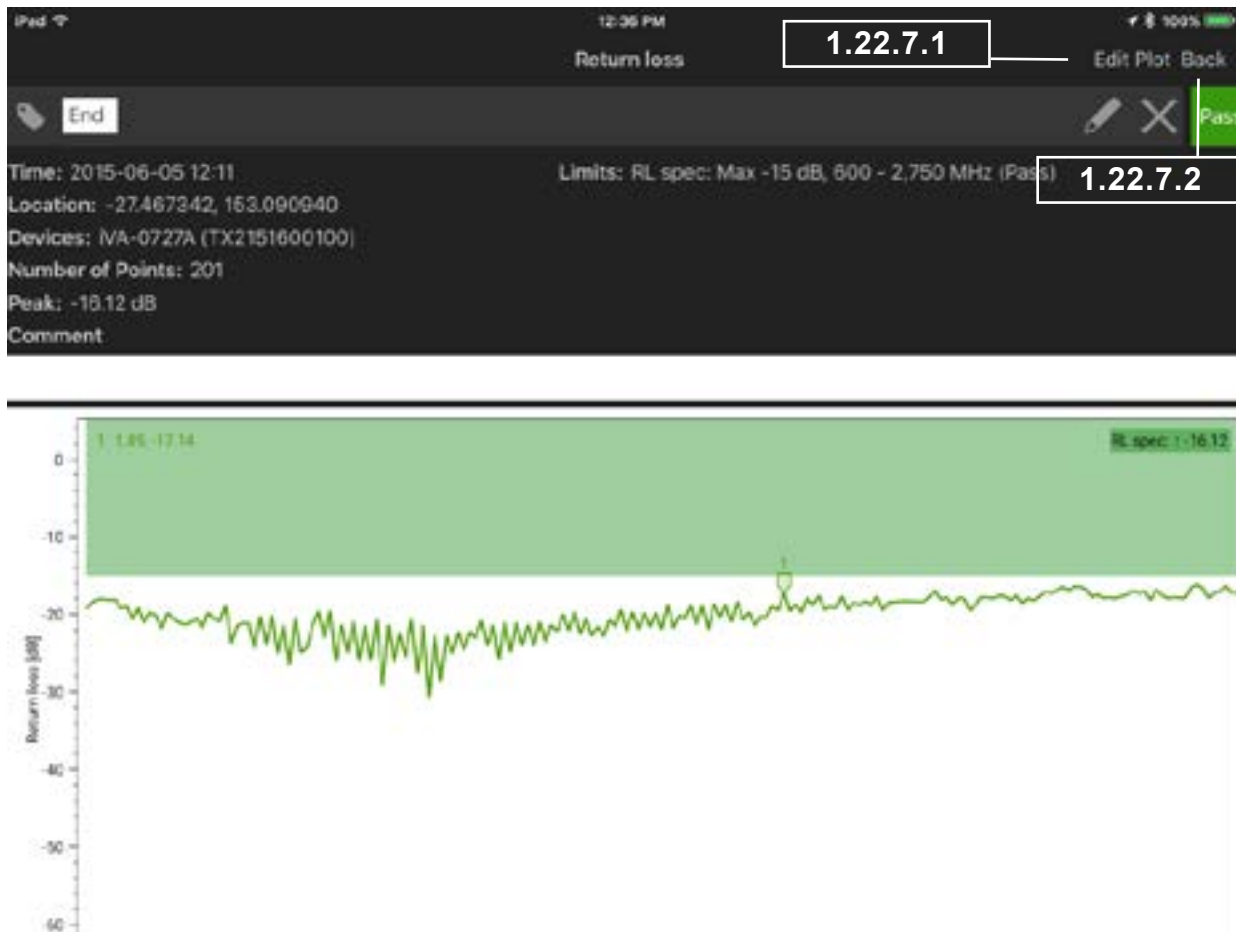

Figure 39 Plot expanded view (Reports)

1.22.7.1 Edit Plot

Pressing the Edit Plot label allows you to edit/add the Plot Markers, View Scale and visibility of the trace and markers. When you are satisfied with your edits save the plot to return to the previous menu or preview to check your progress before saving. See Figure 40 . Marker editing or addition is the same functionality as in Section 1.19.2.1 , for Trace Scaling See Section 1.14.

1.22.7.2 Back

Returns to the previous screen.

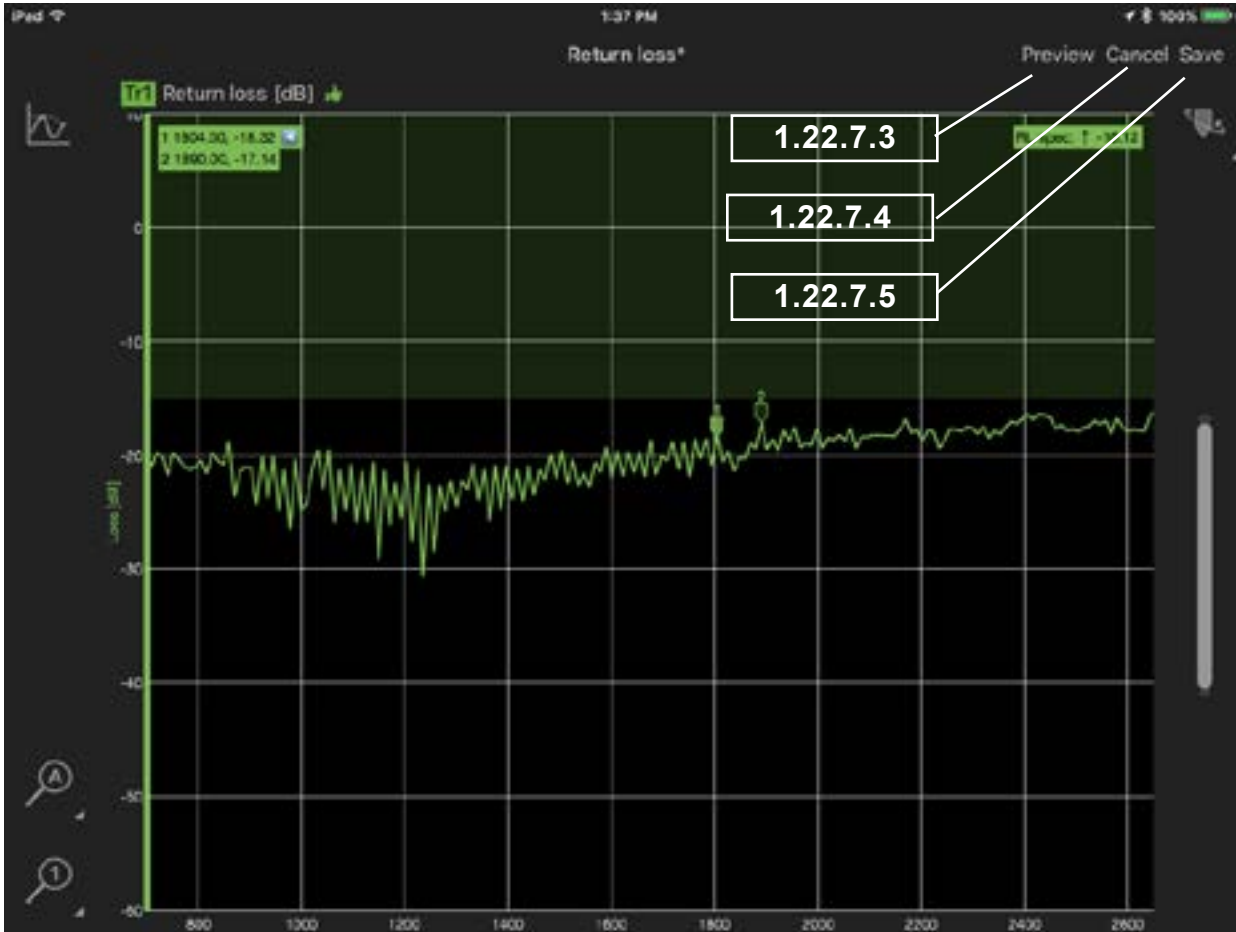

Figure 40 Edit Plot View

1.22.7.3 Plot Preview

Preview returns you to the Plot expanded view, to Preview the results of your changes. Return to this this menu with the edit function and save your changes.

1.22.7.4 Cancel

Once pressed a Pop-up menu will appear asking if you want to Cancel/Save your edits before you return to the previous screen.

1.22.7.5 Save

Save the changes to your edited plot to the report in memory. Note : You still need to save your report once all you plot edits are completed. See Section 1.22.1.4 .

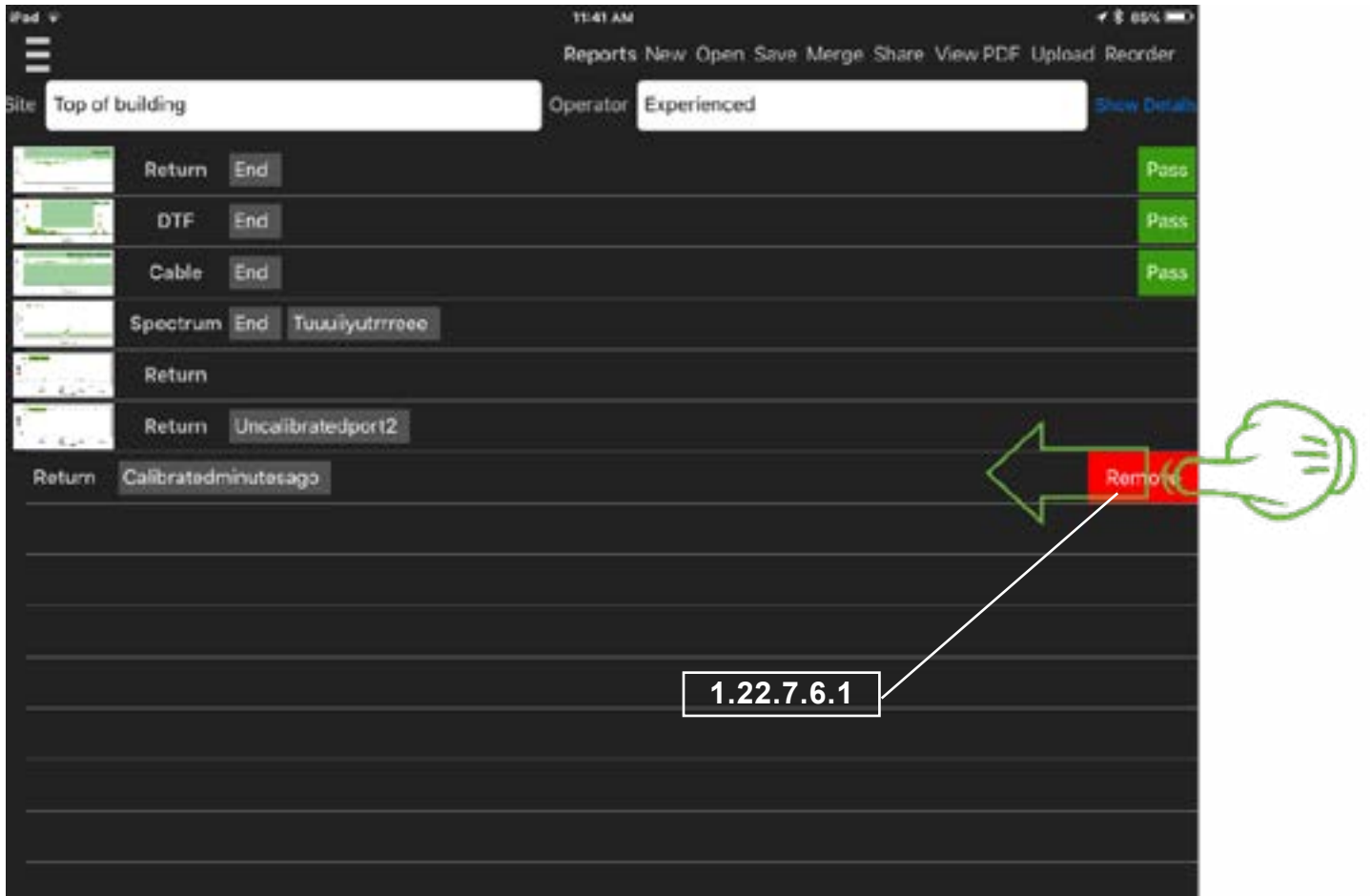

Figure 41 Remove a Plot

1.22.7.6 Removing a Plot

Preview returns you to the Plot expanded view, to Preview the results of your changes. Return to this this menu with the edit function and save your changes.

1.22.7.6.1 Remove Plot Icon

To make the Remove icon visible press and slide in from the edge of the display as shown in Figure 41. Press the remove plot icon to remove the plot on the current line. Pressing another plot thumbnail will cause the remove plot icon to retract again.

1.23 State Files

It is possible to save instrument setups to a state file, these include Tags, Limits, Modes, Traces and Markers. It is worth spending some time to organize your test setups and workflow with some state files. State files can be sent and shared via normal sharing mechanisms, email, Dropbox, Airdrop etc depending on what is installed. Sharing choices are available when entering the state menu. Windows and Android can directly access state files via export or file browsing where iOS may restrict access via file sharing services .

1.24 Settings

1.24.1 General Menu

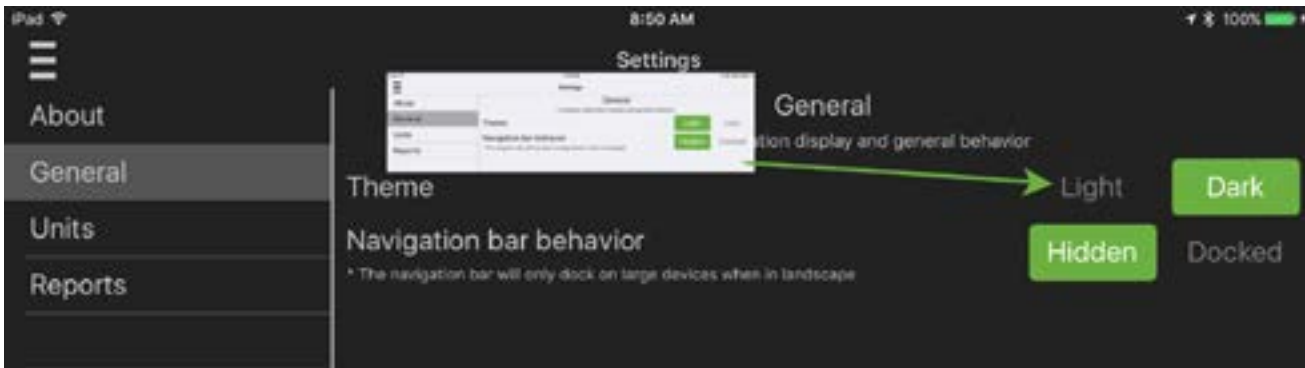

Figure 42 Settings General Menu

Light or Dark Color themes can be set for the application here. On Larger screen devices the menu side panel can be set to Docked, this keeps the side panel in place and scales the trace display to be in the remaining space. Hidden mode allows for the side panel to slide away out of site when not used.

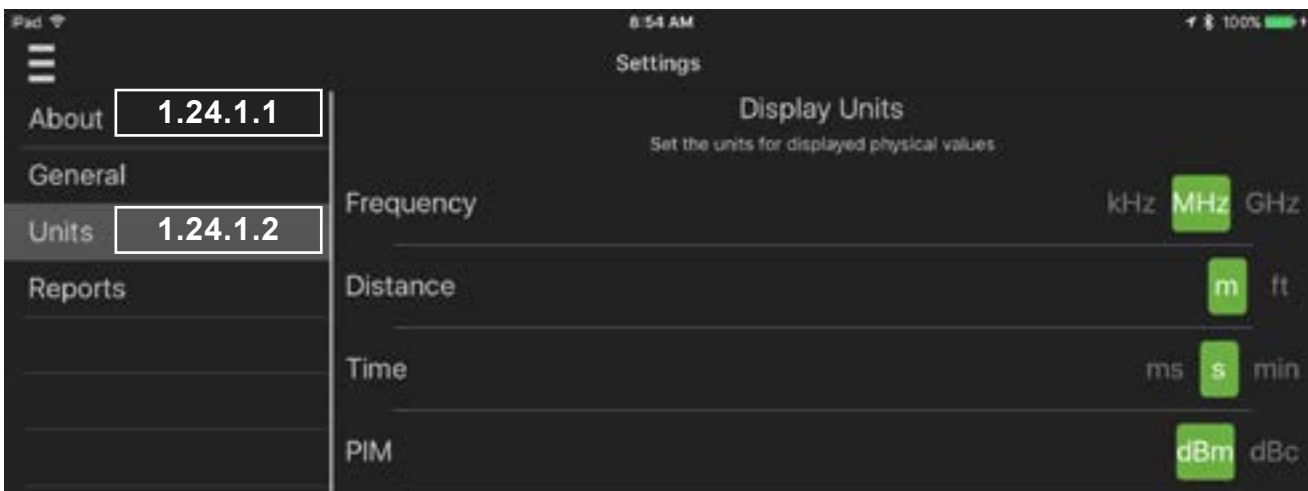

Figure 43 Settings Units

1.24.1.1 About Settings Menu

About shows the software version number.

1.24.1.2 Units Settings Menu

Units allows you to select the frequency, distance, time and PIM measurement Units used. Note : The PIM units selection is used when PIM reports from a Kaelus PIM analyser are imported. Test Reports allows you to set contractor details and logo. See Section 1.22.2

1.25 Cleaning the Equipment

Before commencing any cleaning, switch off the equipment. We recommend that the exterior surface of the equipment case is cleaned using a soft cloth moistened in water. Do not use aerosol or liquid solvent cleaners.

The test connector should be protected from dirt and scratches and cleaned with lint free cotton bud with isopropyl alcohol.

Care should be taken not to scuff, scratch or damage internal RF mating surfaces. Do not rotate the body of the iVA when connecting to a cable, rotate the fastening nut of the connector. When cleaning is a good time to inspect the connector and insure it is in good condition and if it requires servicing.

1.26 Turning off the IVA

Press and hold the Power Switch, See Figure 5 , for approximately 3 seconds until both Tx and Rx LED's flash, then lift your finger from the switch then it will turn off.

2. Troubleshooting Guide

If the remedies indicated in the chart below do not solve the problem, consult the manufacturer for further instructions.

Power

No Power upon pressing power switch

- Charge the battery with the iVA switched off for 3.5 Hrs with the included charger and small USB cable supplied. Confirm the Orange LED is on while charging.
- If the Orange LED does not come on, swap the charger to a known working power outlet.
- After sufficient charging time has passed then attempt to switch the iVA on again. See Section 1.7
- If the above action does not fix the problem the test set should be returned to a Kaelus/Summitek approved service facility.

Operation

Unable to Connect Via Bluetooth

- If the Bluetooth LED is solid Blue (Not flashing). Another user device may be in control/connected to your iVA. Switching off the iVA (See Section 1.26) , will force the current controller to disconnect. Switch on the iVA (See Section 1.8) and attempt to connect via Bluetooth while the LED is flashing (See Section 1.10.2)
- Ensure you are attempting to connect to the correct serial number iVA. Check that the serial number of your iVA is in the devices list (See Section 1.10.2.1 and Figure 11), if not in the list you may need to manually start the scanning process to locate it and have it added to your device list, once in the list you should be able to connect.
- Signal Strength, typically you are able to connect and control up to 400 Meters away. Being inside a building can reduce this range significantly.
- Interference, test environments can be co-sited with high power transmitters or environments with high transmitted noise floors. Powering off interferers while testing can assist with interference problems.
- Resetting the Apple device Bluetooth hardware: switching off Bluetooth on the Apple device and switching it back on again can assist. Likewise pairing again to your iVA serial number in the Bluetooth menu will allow the new connection to occur quicker.

Geotag

- Geotag data may not be available inside a building or where high RF fields are present. Secure your location on your smart phone or your Apple device before connecting wirelessly to the iVA or entering the building.
- Geotag data is only as good as the information provided by the location service on your Apple device. If your device has GPS or location services, ensure they are switched on in the settings menu. Some devices may not have a GPS receiver and may not be able to use Satellite location services.

- Geotag service providers can gather geo data from several sources. Having more data sources turned on and shared with your geotag service provider can improve your chances of an adequate fix. These include GPS (Global Positioning System) switched on and set to share your location (if fitted), Wi-Fi access points that can be received nearby, Cellular Phone tower signals being received nearby for smartphones or cellular enabled tablets, and an internet data connection can all assist to get a geotag fix.
- If your user device Wi-Fi is your only Geotag data collection source, get your geotag fix first then use the Wi-Fi to connect to an internet connection.
- You can use your map application on your user device to confirm you have a Geotag fix for your location this can help isolate problems with your Geotag fix.

Unable to Measure Cable Loss

- Cable loss measurement uncertainty increases as cable loss increases, if you suspect very high cable loss. The reflected signal from the cable end may become too low to measure. Check the terminated return loss of your cable, if the connectors or assemblies at the start of cable are very poor. This can create a reflected signal stronger than the cable loss measurement signal. Attend to any local return loss problems first, before attempting your cable loss measurements.

3. End of Life Statement

Equipment marked with the symbol below (Crossed Out Wheelie Bin) complies with the European Parliament and Council Directive 2002/96/EC (the “WEEE Directive”) in the European Union.

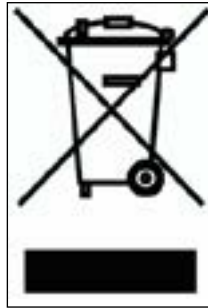

Please contact your local Kaelus representative (see next section) at the end of the product’s useful life to arrange its disposal in accordance with your local regulations.

4. Contacts

Kaelus has service center locations globally. Please visit <https://www.kaelus.com/en/contact-us> to find the service center nearest you.

When ringing, ask for IM tester support (technical or otherwise) & quote the relevant part numbers.

Send feedback to: info@Kaelus.com